



HOW TO INTEGRATE THE FISCHER L.U.C.™ INTO YOUR APPLICATION

CONTENTS

| | |
|---|----|
| • Intended use | 2 |
| • Precautions | 2 |
| • Sterilization methods | 2 |
| - Gamma irradiation | 2 |
| - Ethylene Oxide (EtO) | 2 |
| • Disposal / Recycling | 2 |
| • Customer information assistance | 2 |
| • Warranty | 2 |
| • Basic configurations | 2 |
| • Cable solutions | 3 |
| | 3 |
| • Assembly | 4 |
| | 4 |
| Two-Piece Shell | 4 |
| I - Connector parts | 4 |
| II - Available inner volume | 4 |
| III - Customization areas | 4 |
| IV - Cable stripping dimensions | 5 |
| STEP 1 - Slide parts on the cable | 5 |
| STEP 2 - Terminate contact block | 5 |
| STEP 3 - Crimp ferrule | 6 |
| STEP 4 - Close the connector | 6 |
| One-Piece Shell | 8 |
| I - Connector parts | 8 |
| II - Customization area | 8 |
| III - Cable stripping dimensions | 8 |
| STEP 1 - Slide parts on the cable | 8 |
| STEP 2 - Terminate contact block | 8 |
| STEP 3 - Crimp ferrule | 9 |
| STEP 4 - Close the connector | 9 |
| Overmoldable & Snap-in Plug | 10 |
| I - Connector parts | 11 |
| II - Cable stripping dimensions | 11 |
| STEP 1 - Terminate contact block | 11 |
| STEP 2a - Overmold interface and cable | 11 |
| STEP 2b - Snap interface into housing | 11 |
| | 12 |
| • APPENDIX 1 - Contact blocks | 13 |
| • APPENDIX 2 - Examples of crimping dies design | 15 |
| • APPENDIX 3 - Overmolding of cable retention | 16 |
| • APPENDIX 4 - Suggestions for inner customization | 17 |
| • APPENDIX 5 - Documents and 3D CAD model files | 18 |

This document is the property of Fischer Connectors SA.

All communications to third parties or the reproduction in any form, even partial, are prohibited without our written consent.

INTENDED USE

- The Fischer L.U.C.™ must not be implanted or introduced inside the body, either through a body orifice or through the surface of the body.
- The Fischer L.U.C.™ must not be used to transport body fluids or to deliver medicinal products.
- The Fischer L.U.C.™ is intended for continuous use for not more than 30 days.
- Do not use the Fischer L.U.C.™ for more than 10 mating cycles.

PRECAUTIONS

The end user must not pull on the cable to disconnect the connector but always handle the connector housing for this action. We strongly suggest the Device Manufacturer adds a warning such as this in their own user's manual.

STERILIZATION METHODS

This product is designed to withstand one cycle of the following sterilization methods. It must not be re-sterilized:

- Gamma irradiation

The Fischer L.U.C.™ has been tested to withstand irradiation values above those typically used in the industry. Fischer Connectors did not determine the minimum permissible dose necessary to provide the required or desired SAL (sterility assurance level). This requirement is dependent upon the intended use of the product.

- Ethylene Oxide (EtO)

The Fischer L.U.C.™ has been tested with a standard EtO sterilization cycle validated in accordance with EN 550 / ISO 11135. Fischer Connectors did not determine the minimum permissible exposure time necessary to provide the required SAL. This requirement is dependent upon the intended use of the product.



This product shall not be sterilized with a steam autoclave or with any other method that exposes the product to more than +65 °C/ +149 °F.

If any sterilization method other than the ones listed above is used, it is the MDM's (Medical Device Manufacturer) responsibility, not Fischer Connectors', to qualify this product with this sterilization method. Fischer Connectors refuses to accept responsibility for any product performance degradations, if sterilization is not done by gamma radiation or EtO.

DISPOSAL / RECYCLING

Our products comply with the European Parliament Directive 2002/95/EC (RoHS).

As the Fischer L.U.C.™ is specifically designed for single-use devices, we recommend that the Device Manufacturer adds the following directives in their own user's manual:

Single-use devices

A single-use device is intended to be used once and then discarded.

Any piece of equipment designated as single use should not be decontaminated.

If a staff member prepares a single-use product for further use, then legal liability for the safe performance of the product is transferred from the manufacturer to the staff member or to the organization that employs him/her.

Single-use products are labeled with the words 'single-use' or similar and marked with the symbol:



See BS EN 980:1997 'Graphical symbols for use in the labeling of medical devices' British Standards Institute, 1997.

CUSTOMER INFORMATION AND ASSISTANCE

We thank you for selecting Fischer Connectors and hope that the Fischer L.U.C.™ will truly contribute to the success of your application.

Proper assembly of the connector is essential for electrical performance and reliable operation. Our extensive network of subsidiaries and distributors is here to provide our customers with technical support and extensive guidance.

Log on to www.fischerconnectors.com to find the contact details of your local office.

WARRANTY

The Fischer L.U.C.™ is warranted to be free of defects in material and workmanship for 12 months after delivery to the first purchaser for use, providing that the connector has not been misapplied. Fischer Connectors' obligations hereunder, at Fischer Connectors' option, are limited to replacement, or refund of purchase price, and parts which upon examination prove to be defective within the warranty period specified. This warranty does NOT apply to damage resulting from transportation, inadequate storage, alteration, misuse, abuse, use with counterparts other than Fischer Connectors', inappropriate sterilization method or improper assembly. Consequential and incidental damages are not recoverable under this warranty.

BASIC CONFIGURATIONS

Specifically engineered for disposable devices, the Fischer L.U.C.™ (Limited Use Connector) offers multiple configurations and optimally suits a wide array of applications, from catheters to surgical hand tools and more. This Application Guide has been designed to help you integrate the Fischer L.U.C.™ into your application. It covers the assembly of each of the following four basic configurations:

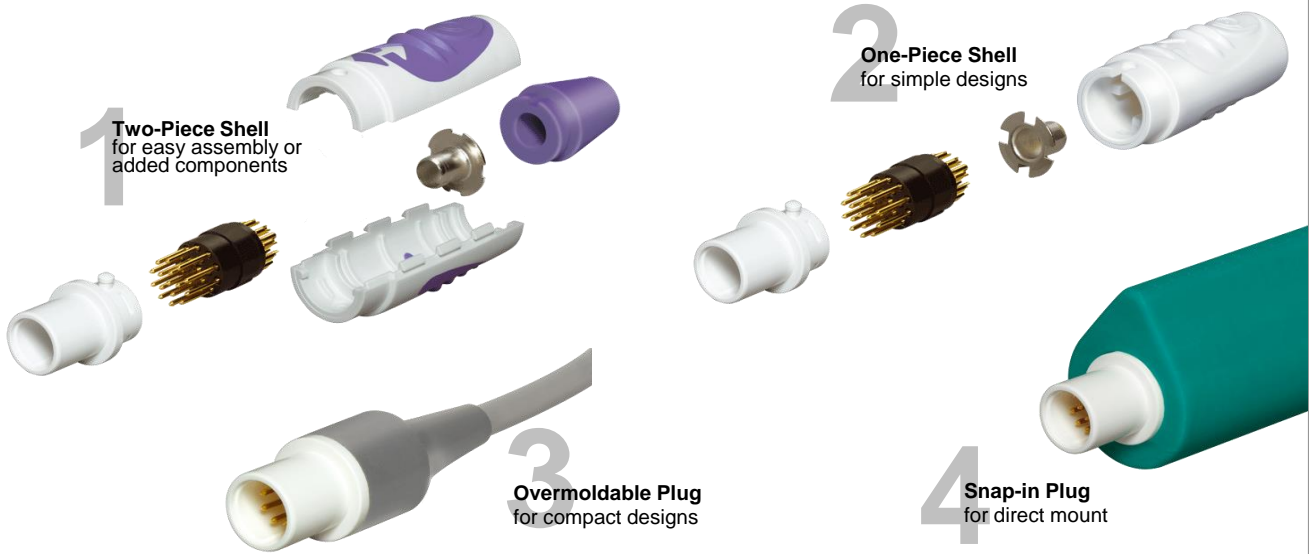

CABLE SOLUTIONS

The connector configurations can be used in various combinations of cable interconnection. There are 3 types of usual cable configurations. Each type has its own ergonomic, economic, and logistical advantages.

Type 1 - Connects the single-use handpiece to a reusable console via a long length of disposable cable. The cable is hardwired to the handpiece on one end, and has either a Two-Piece, a One-Piece or an Overmolded L.U.C.™ solution on the other end, which connects to a standard Fischer high mating cycle receptacle on the console.

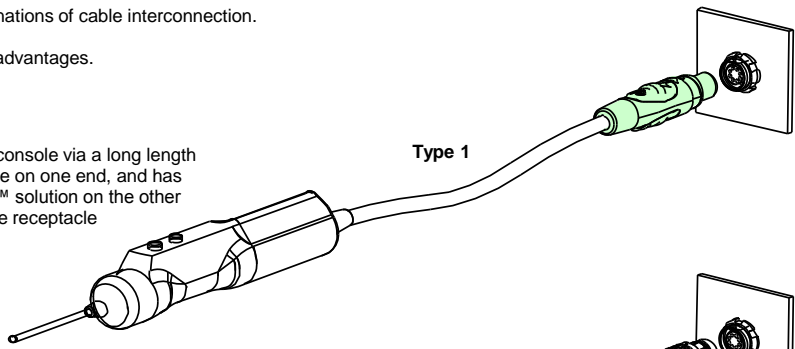

Type 2 - Is similar to Type 1, but the length of disposable cable is much shorter, and the L.U.C.™ solution chosen connects to an intermediate cable instead of directly to the console. The intermediate cable uses standard Fischer male and female high mating cycle cable connectors to complete the connection to the console. The intermediate cable can be designed for disposal, wipe down or autoclave.

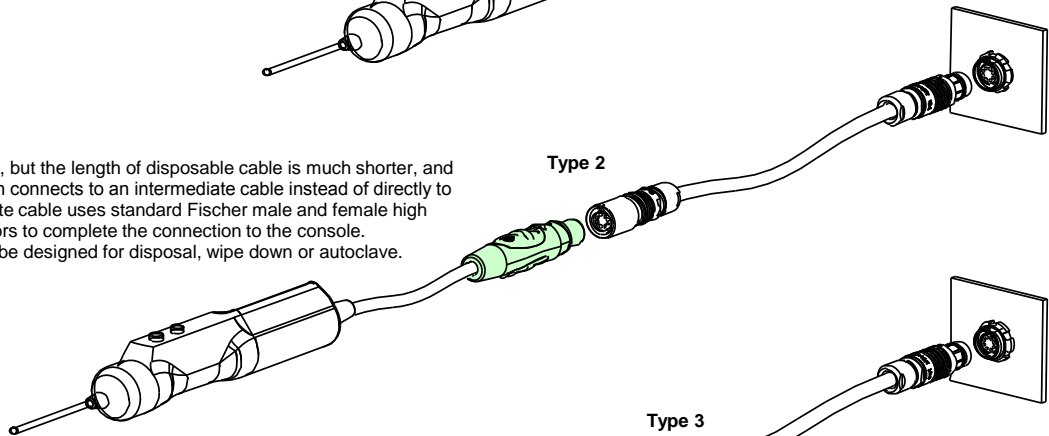

Type 3 - Is similar to Type 2, and also uses an intermediate cable with standard Fischer cable connectors to complete the connection to the console, but there is no disposable cable hardwired to the single-use handpiece. The L.U.C.™ Snap-in Plug mounts directly to the handpiece. As with Type 2, the intermediate cable can be designed for disposal, wipe down or autoclave.

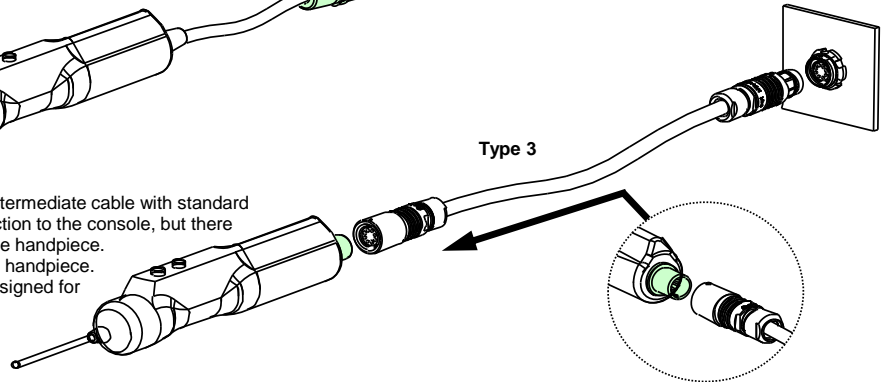



ASSEMBLY

I - Connector Parts

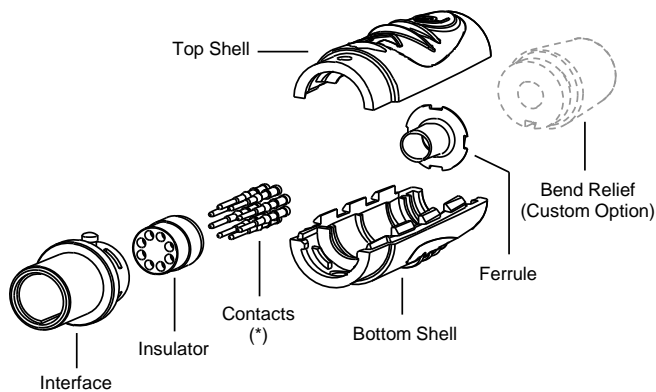

* Solder contacts are mounted in the Insulator.

* Some crimp contact types can be available on strip & reel. Please contact us for more information.

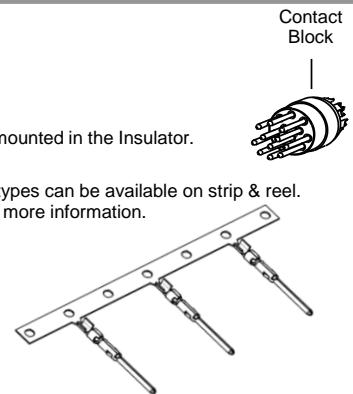

II - Available Inner Volume

The inner volume of the connector is basically cylindrical as described below. It contains the following items:

- Embedded electronics (if any)
- Cable (mainly the wires)
- Solder barrels of contacts (only for solder contacts)
- Cylindrical portion of Ferrule if it is turned toward the inside of the connector (see STEP 1.3)

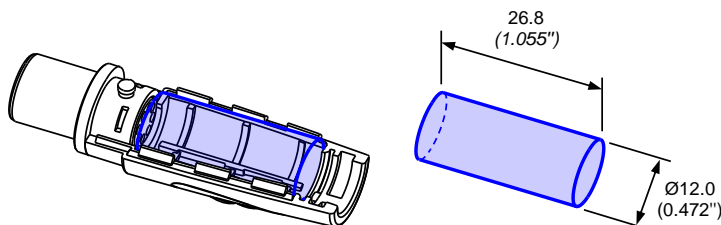

Detailed 3D CAD model available on request:
See **Appendix 5** for more details.

III - Customization Areas

The logo and the inner geometry of the Bottom Shell can be customized. See green areas below.

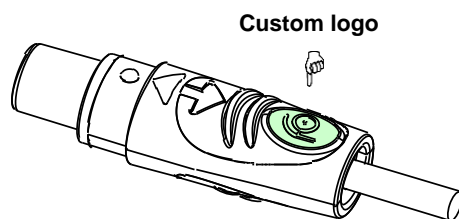

Custom logo

Customizable inner area of Bottom Shell

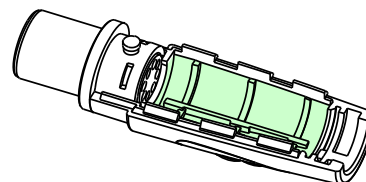

☞ Allows implementation of special features such as custom fixation of electronic components, etc. See **Appendix 4** for suggestions.

All dimensions shown are in millimeters (*inches*) and are for reference only.



IV - Cable Stripping Dimensions

- Dimension **L1** depends on the type of contacts used. Please refer to the table in **Appendix 1** for values.
- Dimension **L2** is typical and has to be adjusted according to cable construction and dimensions.

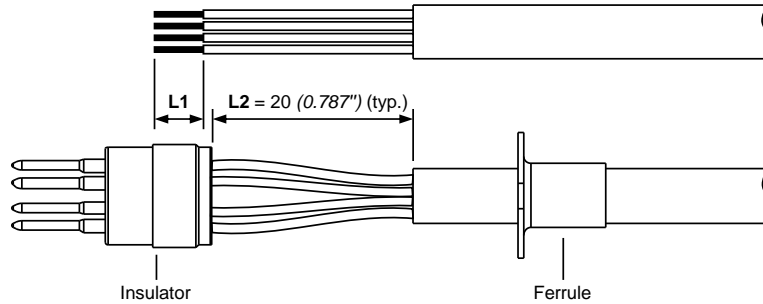

STEP 1 - Slide Parts on the Cable

- 1.1 Strip cable.
- 1.2 Slide the Bend Relief (if any) onto the cable.
- 1.3 Slide the Ferrule onto the cable.
 - ☞ The Ferrule can be turned with its cylinder portion either toward the inside (**A**) or toward the outside (**B**) of the connector. Solution B gives more space inside the housing for embedded electronics but the Ferrule is visible if the connector has no Bend Relief.

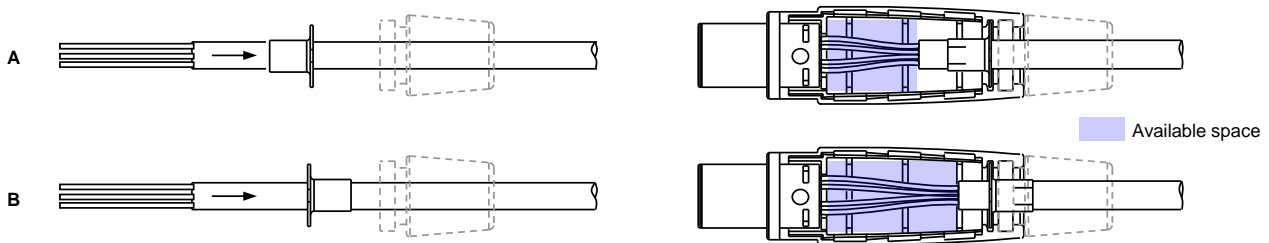

STEP 2 - Terminate Contact Block

- 2.1 Strip cable wires.
- 2.2 Crimp (or solder) Contacts on cable wires.
 - ☞ See **Appendix 1** for wire size, stripping dimension, and tooling.

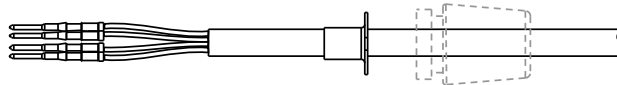

- 2.3 Insert Contacts into Insulator.
 - ☞ There is no pin numbering on the Insulators. Please refer to **Appendix 1**.

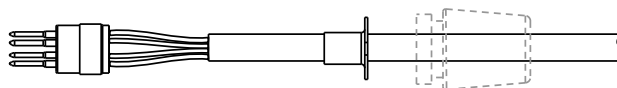



STEP 3 - Crimp Ferrule

3.1 Position the Ferrule at distance L3 from the back side of the Insulator.

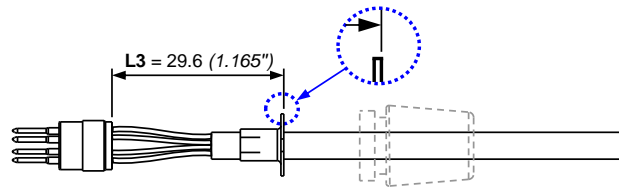

3.2 Orientate the Ferrule with one of the slots parallel to the Insulator nose.

☞ Otherwise the cable wires will be twisted when seating the Ferrule inside the Bottom Shell in STEP 4.3.

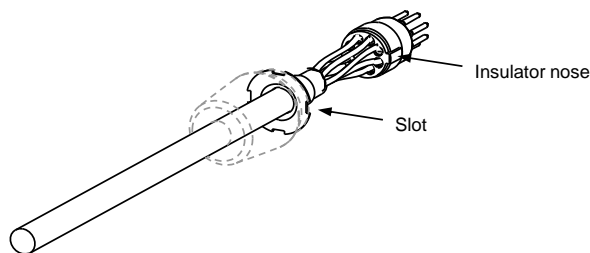

3.3 Crimp the Ferrule.

☞ The cable retention force of the Ferrule depends on the type of Ferrule and cable used, the shape and size of the crimping dies, and on the crimping length. The adequate force is reached with the correct combination of all these parameters. See the examples of crimping shapes in **Appendix 2**.

☞ Depending on the type of crimping used, a guiding slot adjusted to the width of the Ferrule flange in the crimping dies may be necessary to prevent any distortion of the flange.

☞ The Ferrule can be replaced by an overmolding of the cable as described in **Appendix 3**.

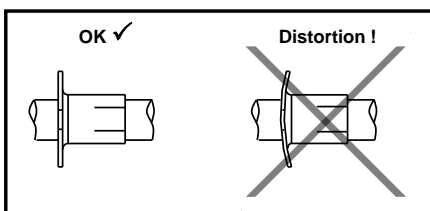
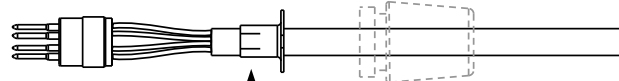

STEP 4 - Close the Connector

4.1 Insert the Contact Block into the back of the Interface.

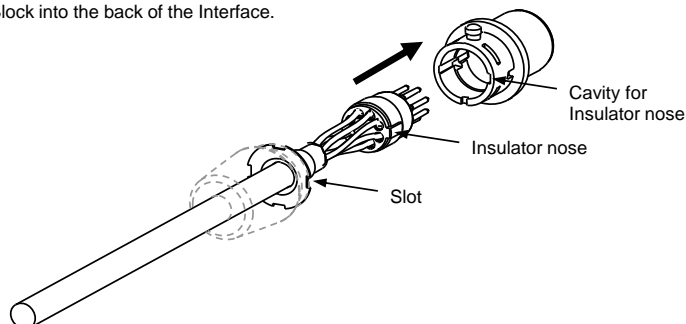

All dimensions shown are in millimeters (*inches*) and are for reference only.



STEP 4 - Close the Connector (cont.)

4.2 Position the Bottom Shell opposite to the Guide Mark of the Interface and snap both parts together.

- ☞ Make sure the Insulator seats properly inside the Interface before snapping the Bottom Shell.
- ☞ Check fit: The surface of the Bottom Shell must be flush to the surface of the Interface on both sides of the connector.

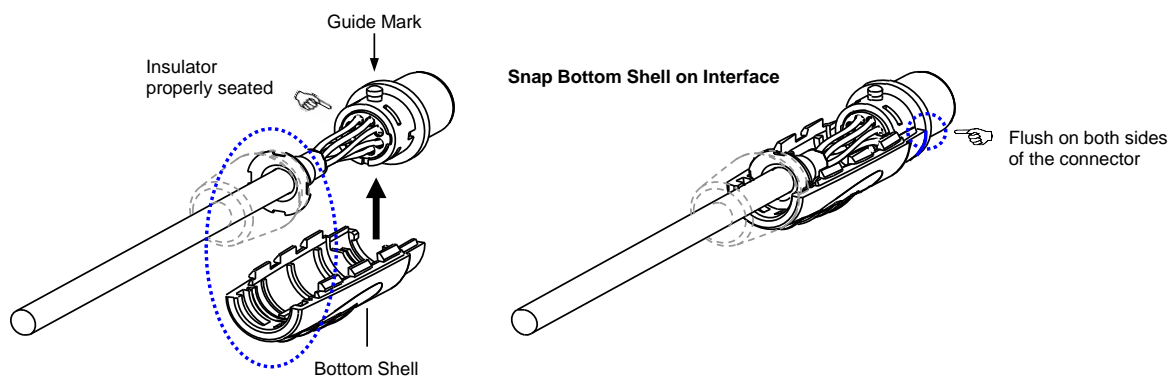

4.3 Put the Ferrule and the Bend Relief (if any) in place inside the Bottom Shell and make sure their slot seats properly in position inside the Shell.

- ☞ See below the respective areas for positioning the Ferrule and the Bend Relief.

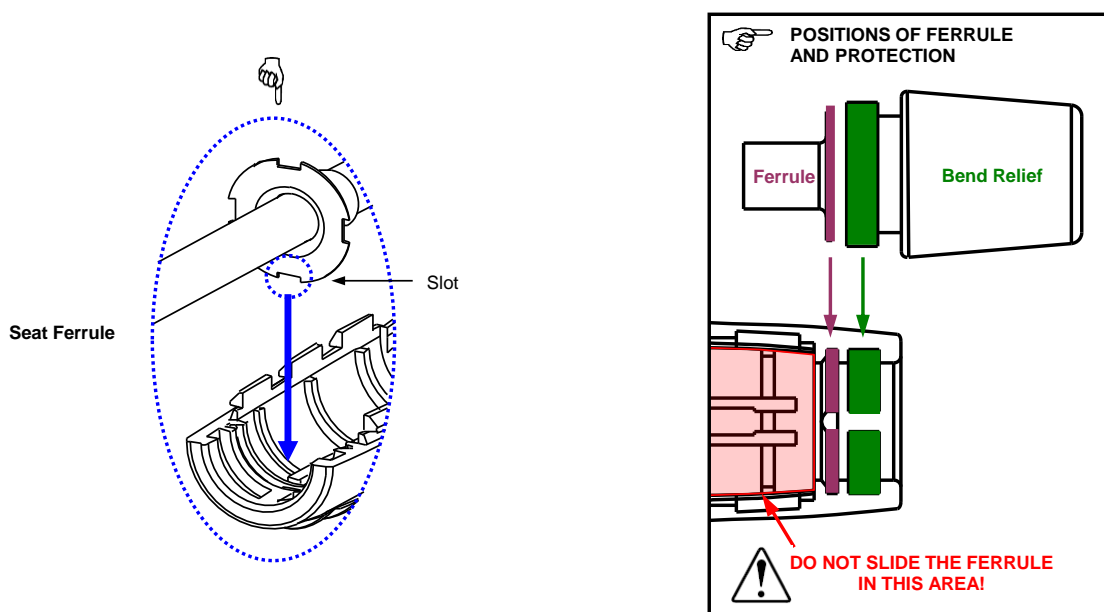

4.4 Align the Top Shell over the Bottom Shell then snap both Shells together.

- ☞ While snapping the Shells, hold down the cable to the Bottom Shell so that the Ferrule remains in position. If the Ferrule jumps and turns while snapping, both Shells won't close.
- ☞ Check fit: The Shells must be in contact with each other along their full length.

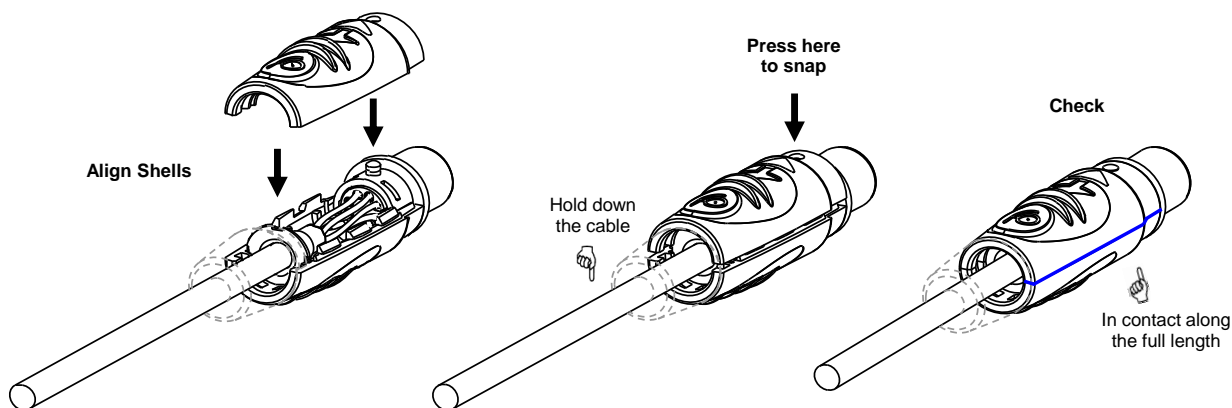



I - Connector Parts

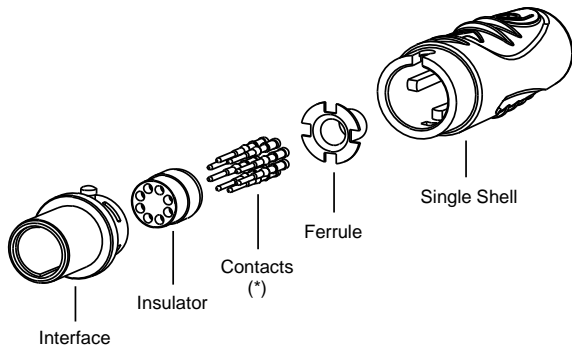

* Solder contacts are mounted in the Insulator.

* Some crimp contact types can be available on strip & reel. Please contact us for more information.

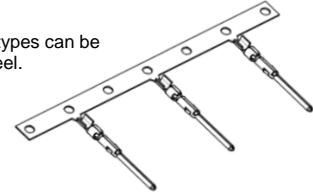
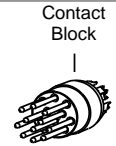

II - Customization Area

The logo can be customized. See green area below.

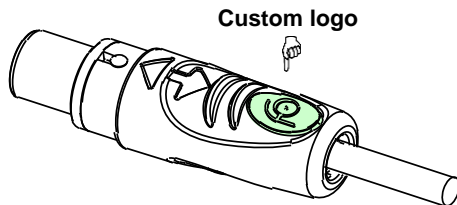

III - Cable Stripping Dimensions

- Dimension **L1** depends on the type of contacts used. Please refer to the table in **Appendix 1** for values.
- Dimension **L2** is typical and has to be adjusted according to cable construction and dimensions.

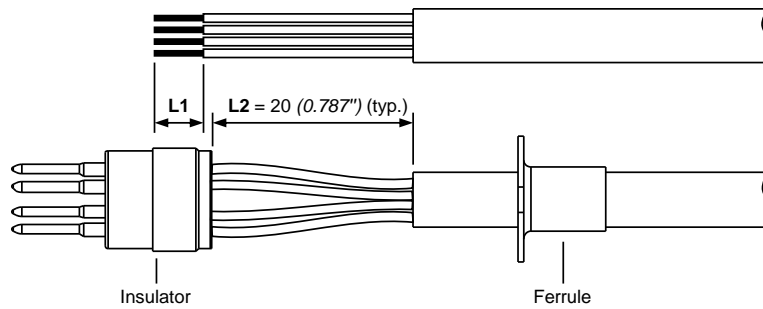

STEP 1 - Slide Parts on the Cable

- 1.1 Strip cable.
- 1.2 Slide the Shell and the Ferrule onto the cable.
- 1.3 Optional: Add semi-rigid shrink tubing to stiffen the wire so that it does not push inside. The Ferrule relieves cable pull only.

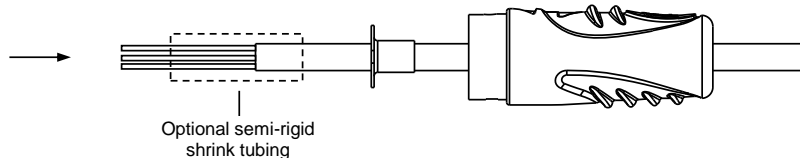

All dimensions shown are in millimeters (*inches*) and are for reference only.



STEP 2 - Terminate Contact Block

- 2.1 Strip cable wires.
- 2.2 Crimp (or solder) Contacts on cable wires.
 - ☞ See **Appendix 1** for wire size, stripping dimension, and tooling.

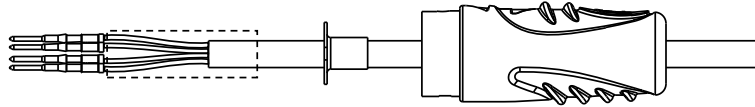

- 2.3 Insert Contacts into Insulator.
 - ☞ There is no pin numbering on the Insulators. Please refer to **Appendix 1**.
- 2.4 Heat semi-rigid shrink tubing (if any).

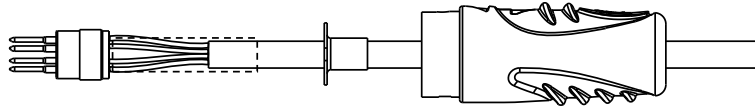

STEP 3 - Crimp Ferrule

- 3.1 Position the Ferrule at distance **L4** from the back side of the Insulator.

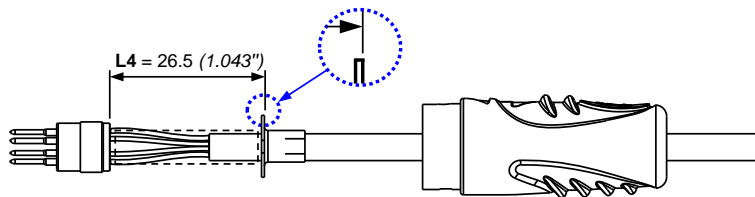

- 3.2 Orientate the Ferrule with one of the slots parallel to the Insulator nose.
 - ☞ Otherwise the cable wires will be twisted when snapping the Shell to the Interface in STEP 4.3.

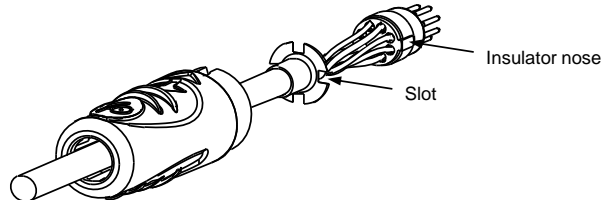

- 3.3 Crimp the Ferrule.
 - ☞ The cable retention force of the Ferrule depends on the type of Ferrule and cable used, the shape and size of the crimping dies, and on the crimping length. The adequate force is reached with the correct combination of all these parameters. See the examples of crimping shapes in **Appendix 2**.
 - ☞ Depending on the type of crimping used, a guiding slot adjusted to the width of the Ferrule flange in the crimping dies may be necessary to prevent any distortion of the flange.
 - ☞ The Ferrule can be replaced by an overmolding of the cable as described in **Appendix 3**.

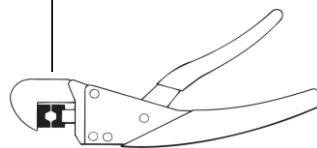
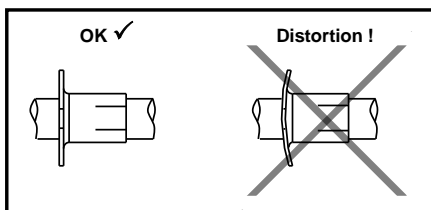
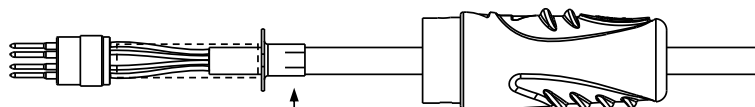

All dimensions shown are in millimeters (*inches*) and are for reference only.



STEP 4 - Close the Connector

4.1 Insert the Contact Block into the back of the Interface.

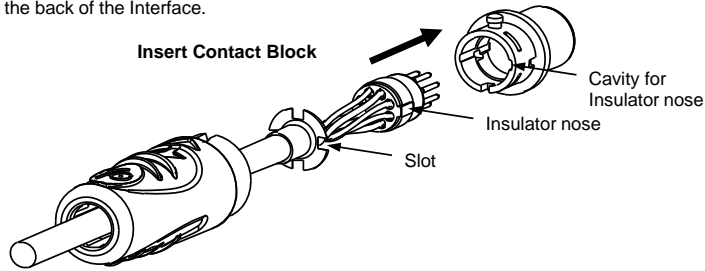

4.2 Align the Guide Marks of the Interface and Shell and slide the Ferrule inside the Shell.

- ☞ The Ferrule prevents the cable from being pulled out but not from being pushed inside the Shell.
- ☞ If desired the Ferrule can be glued to the Shell.

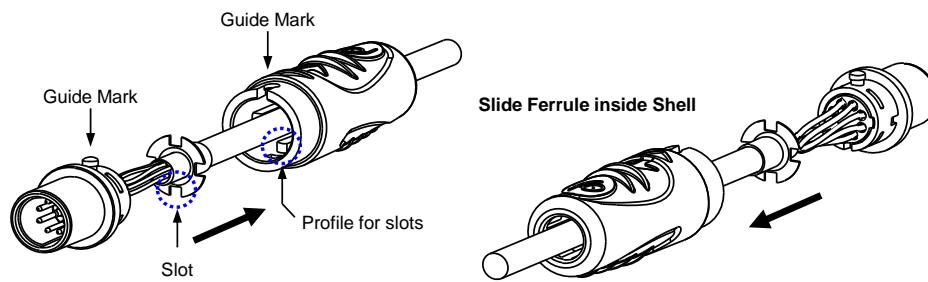

4.3 Snap the Shell to the Interface.

- ☞ Make sure the Insulator seats properly inside the Interface before snapping the Shell.
- ☞ Check that the Shell is in contact with the Interface.

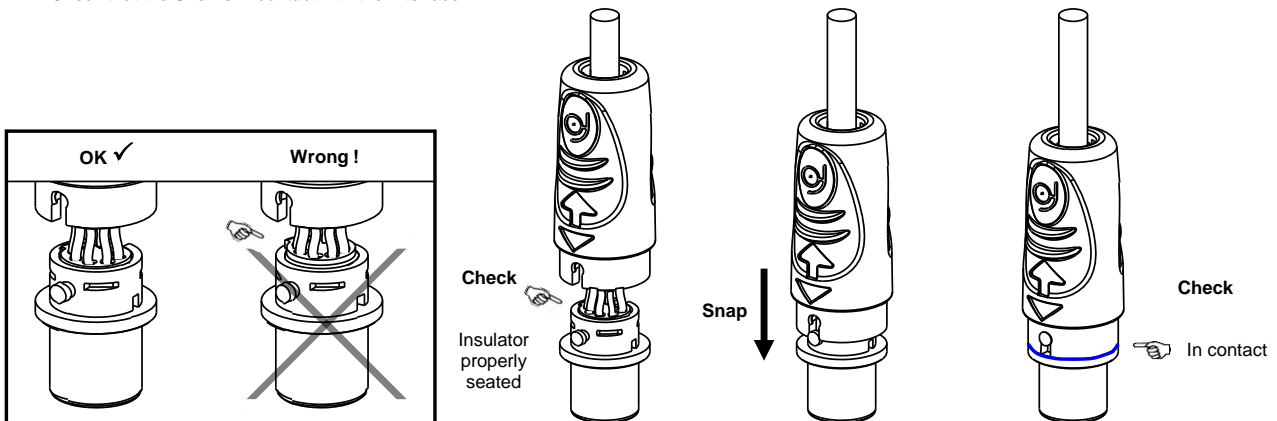



I - Connector Parts

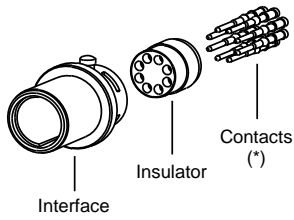

* Solder contacts are mounted in the Insulator.

* Some crimp contact types can be available on strip & reel. Please contact us for more information.

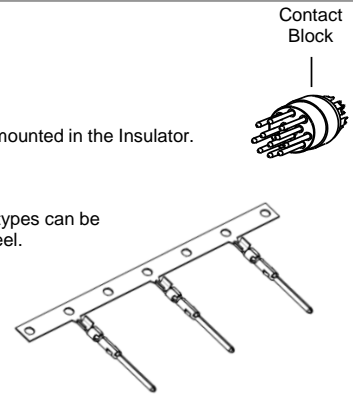

II - Cable Stripping Dimensions

- Dimension **L1** depends on the type of contacts used. Please refer to the table in **Appendix 1** for values.
- Dimension **L2** is typical and has to be adjusted according to cable construction and dimensions.

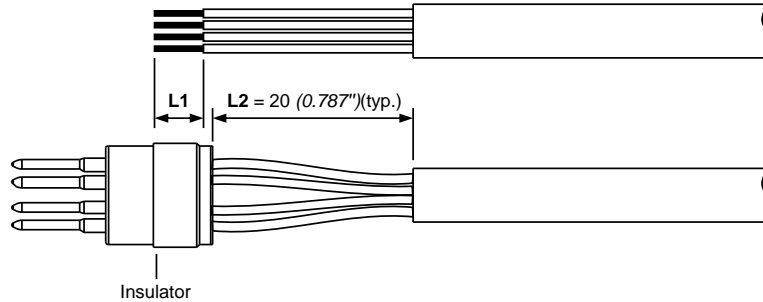

STEP 1 - Terminate Contact Block

- 1.1 Strip cable wires.
- 1.2 Crimp (or solder) Contacts on cable wires.
☞ See **Appendix 1** for wire size, stripping dimension, and tooling.

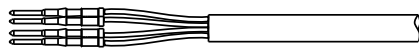

- 1.3 Insert Contacts into Insulator.
☞ There is no pin numbering on the Insulators. Please refer to **Appendix 1**.

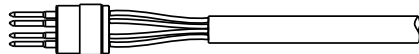

STEP 2a - Overmold Interface and Cable

- 2a.1 Insert the Contact Block into the back of the Interface.

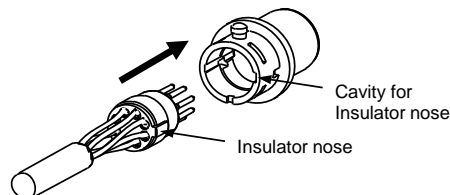

All dimensions shown are in millimeters (*inches*) and are for reference only.



STEP 2a - Overmold Interface and Cable (cont.)

2a.2 Overmold

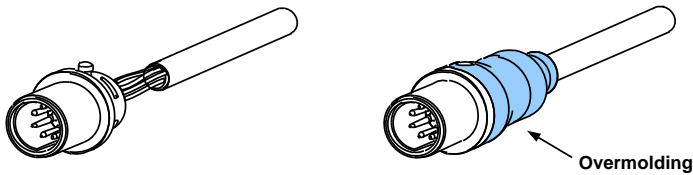

Cautions!

- ☞ Overmold material and process must be selected with care to prevent deformation.
- ☞ The block does not stay retained in the Interface part.
- ☞ Prior to overmolding, the contact block must be sealed in place. This positions the block and prevents "blow-by" of mold material.

STEP 2b - Snap Interface into Housing

2b.1 Insert the Contact Block into the back of the Interface.

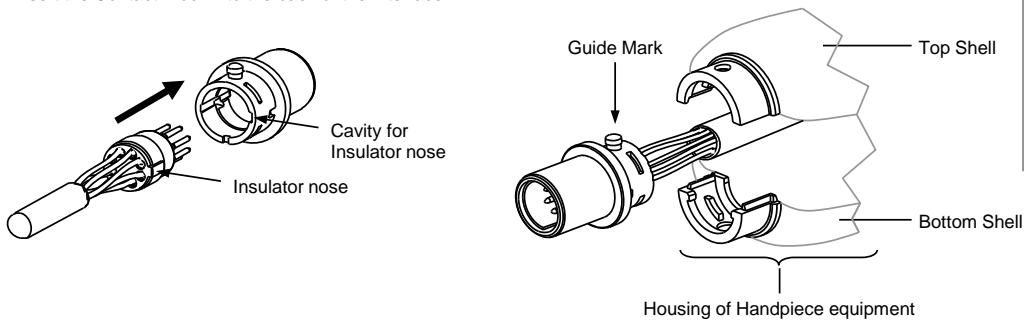

2b.2 Position the Handpiece Bottom Shell opposite to the Guide Mark of the Interface and snap both parts together.

- ☞ Make sure the Insulator seats properly inside the Interface before snapping the Handpiece Bottom Shell.
- ☞ Check fit: The surface of the Handpiece Bottom Shell must be flush to the surface of the Interface on both sides of the connector.

Snap Handpiece Bottom Shell on Interface

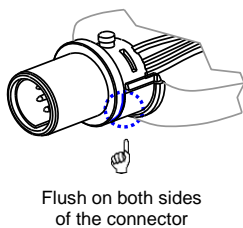

Detailed 3D CAD models available on request:
See **Appendix 5** for more details.



Top fixation



Bottom fixation

2b.3 First align the Handpiece Top Shell over the Handpiece Bottom Shell then snap both Shells together.

- ☞ Check fit: The Shells must be in contact with each other along their full length.

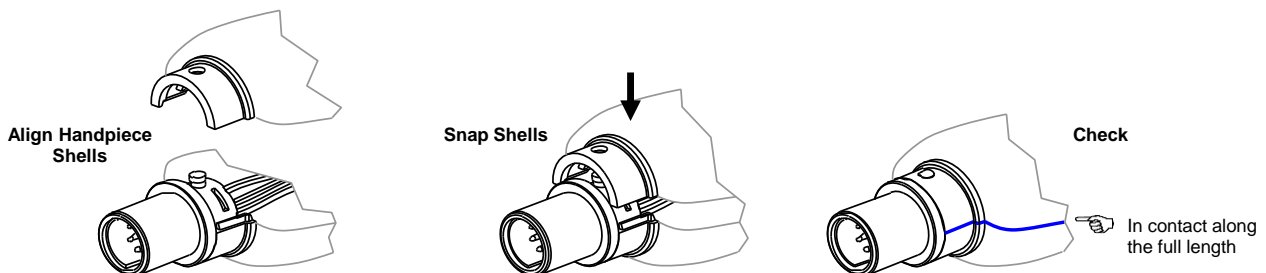

APPENDIX 1 - Contact Blocks

Pin numbering

As there is no pin numbering on the Insulators, please use the figure below:

| Standard Contact Block configurations | | | |
|---------------------------------------|------|------|------|
| | A037 | A066 | A086 |
| | | | |
| Contact size | Ø1.3 | Ø0.9 | Ø0.7 |

A037, A066 and A086 are standard configurations, others available on request.

Wire stripping dimensions

| Contact size | Contact type | | |
|--------------|--------------|----------------------|---------------|
| | Solder | Crimp Screw-machined | Crimp Stamped |
| Ø1.3 | 2.5 (0.098") | 5.0 (0.197") | Not available |
| Ø0.9 | 2.0 (0.079") | 3.5 (0.138") | 2.0 (0.079") |
| Ø0.7 | 2.0 (0.079") | 3.0 (0.118") | 1.8 (0.071") |

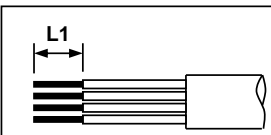

Tools for crimp contacts



| Contact type | Contact size | Part Numbers | | | |
|----------------|--------------|-----------------------|------------|----------------|-----------------|
| | | Crimp Tool | Positioner | Insertion Tool | Extraction Tool |
| Screw-machined | Ø1.3 | TX00.240 | TX00.311 | TX00.273 | TX00.212 |
| | Ø0.9 | TX00.240 | TX00.307 | TX00.211 | TX00.205 |
| | Ø0.7 | TX00.240 | TX00.304 | TX00.210 | TX00.200 |
| Stamped | Ø1.3 | Contact not available | | | |
| | Ø0.9 | TX00.363 (*) | | TX00.341 | TX00.205 |
| | Ø0.7 | TX00.369 (*) | | TX00.210 | TX00.200 |

* Hand tool. For semi-automatic stripper and crimper machine, please contact us for more information.

All dimensions shown are in millimeters (inches) and are for reference only.

APPENDIX 1 - Contact Blocks (cont.)

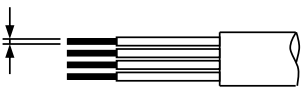
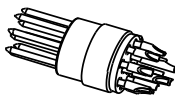
Wire size and contact compatibility table

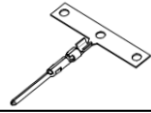
| WIRE SIZE | | | | | CONTACT | | | | | | | | | | | |
|---|-----------|-----------|--------------------|------------|---|------|------|--|------|------|---|------|------|-----|--|---------------|
|  | | | | | Solder | | | Crimp Screw-machined | | | Crimp Stamped | | | | | |
| | | | | |  | | |  | | |  | | | | | |
| AWG | Structure | Stranding | Sectional area | | Size [mm] | | | | | | | | | | | |
| | | | [mm ²] | circ. mils | Ø0.7 | Ø0.9 | Ø1.3 | Ø0.7 | Ø0.9 | Ø1.3 | Ø0.7 | Ø0.9 | Ø1.3 | | | |
| 17 | Solid | 1/17 | 1.0 | 2052 | | | (1) | | | | | | | | | Not available |
| 18 | Solid | 1/18 | 0.82 | 1624 | | | • | | | (3) | | | | | | |
| | Stranded | 7/26 | 0.90 | 1770 | | | | | | | | | | | | |
| | | 16/30 | 0.81 | 1600 | | | | | | | | | | | | |
| 19 | Solid | 1/19 | 0.65 | 1289 | | | • | | | (3) | | | | | | |
| 20 | Solid | 1/20 | 0.52 | 1024 | | | • | | | (3) | | | (3) | | | |
| | Stranded | 7/28 | 0.56 | 1111 | | | • | | | | • | | | • | | |
| | | 10/30 | 0.51 | 1000 | | | • | | | | • | | | • | | |
| | | 19/32 | 0.62 | 1216 | | | • | | | | • | | | • | | |
| | | 26/34 | 0.52 | 1032 | | | • | | | | • | | | • | | |
| | | 41/36 | 0.52 | 1025 | | | • | | | | • | | | • | | |
| 21 | Solid | 1/21 | 0.41 | 812 | • | • | • | | | (3) | | | (3) | | | |
| 22 | Stranded | 7/30 | 0.35 | 700 | • | • | • | | | • | • | | • | • | | |
| | | 19/34 | 0.38 | 754 | | | • | | | • | • | | • | • | | |
| | | 26/36 | 0.33 | 650 | • | • | • | | | • | • | | • | • | | |
| 23 | Solid | 1/23 | 0.26 | 511 | • | • | • | (3) | (3) | (3) | | | (3) | | | |
| 24 | Solid | 1/24 | 0.20 | 404 | • | • | • | (3) | (3) | (3) | | | (3) | | | |
| | Stranded | 7/32 | 0.23 | 448 | • | • | • | (2) | • | • | | | • | • | | |
| | | 10/34 | 0.20 | 397 | • | • | • | • | • | • | | | • | • | | |
| | | 19/36 | 0.24 | 475 | • | • | • | | • | • | | | • | • | | |
| | | 41/40 | 0.20 | 394 | • | • | • | (2) | • | • | | | • | • | | |
| 25 | Solid | 1/25 | 0.16 | 320 | • | • | • | (3) | (3) | | | | | | | |
| 26 | Solid | 1/26 | 0.13 | 253 | • | • | • | (3) | (3) | | | | (3) | | | |
| | Stranded | Any | - | - | • | • | • | • | • | | | | • | | | |
| 27 | Solid | 1/27 | 0.10 | 202 | • | • | • | (3) | | | | | (3) | | | |
| 28 | Solid | 1/28 | 0.081 | 160 | • | • | • | (3) | | | | | (3) | | | |
| | Stranded | Any | - | - | • | • | • | • | | | | | • | | | |
| 29 | Solid | 1/29 | 0.064 | 127 | • | • | • | | | | | | (3) | (3) | | |
| 30 | Solid | 1/30 | 0.051 | 101 | • | • | • | | | | | | (3) | | | |
| | Stranded | Any | - | - | • | • | • | | | | | | • | | | |

Legend

- = Compatible
- = Not compatible

Notes

- (1) The diameter of the wire must not exceed 1.20 mm.
- (2) The diameter of the wire must not exceed 0.61 mm.
- (3) The crimping of solid wires is not recommended as it may lead to unreliable connections.

All dimensions are for reference only.

APPENDIX 2 - Examples of Crimping Dies Design

- ☞ The values indicated below are for information only and shall not be used without validation of the resulting cable retention force.
- ☞ Because cables show a creepage behavior, the measurement results of the retention force depend on the pull test rate. So, the retention force and the test conditions must be clearly defined according to the application's requirements.
- ☞ The cable stiffness can have an important impact on the resulting retention force.

The examples below show realistic values with the following Ferrule and cable size:

Ferrule Dia 5.0 (0.197") Part # U42 504/5.0 for One-Piece Shell
 Part # U33 504/5.0 for Two-Piece Shell

Cable type X

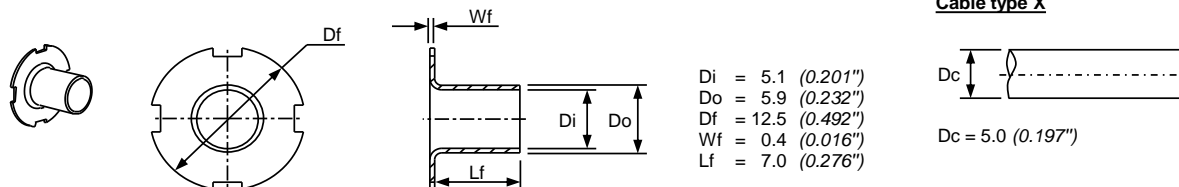

A) Dies with rounded pins

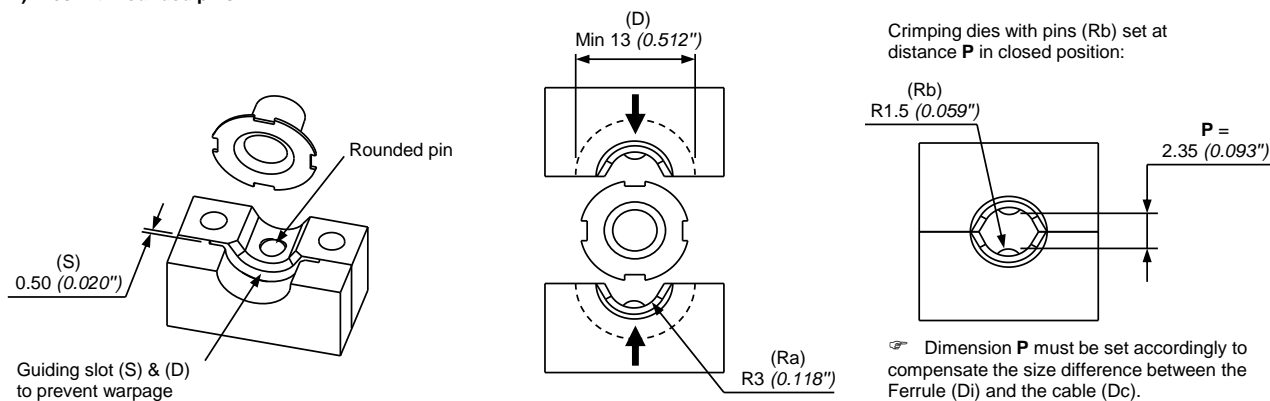

B) Hexagonal crimping dies

- ☞ This shape can only be used when the cable size (Dc) is very close to the Ferrule size (Di).
- ☞ This shape gives much lower retention forces than the dies with rounded pin described above.
- ☞ With this shape there is no risk of warpage of the Ferrule flange if the crimping area is limited (Lc) as shown below.

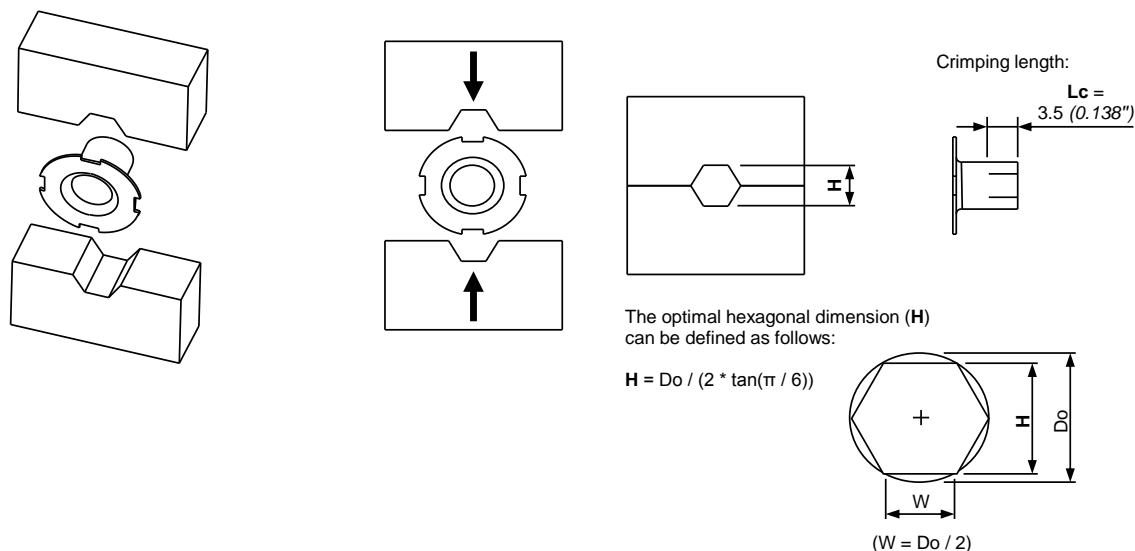

All dimensions shown are in millimeters (inches) and are for reference only.

APPENDIX 3 - Overmolding of Cable Retention

Overmolding the cable can be an alternative solution for the cable retention and replacement of the Ferrule.

- ☞ Select the right material to ensure
 - a sufficient adherence of cable jacket and overmolded materials (by merging or molecular bonding)
 - a sufficient stiffness of overmolded material to stay inside housing when pulling on cable

A) One-Piece Shell

The longitudinal grooves prevent the rotation of the cable in the connector and the back groove prevents the cable from being pushed inside the connector.

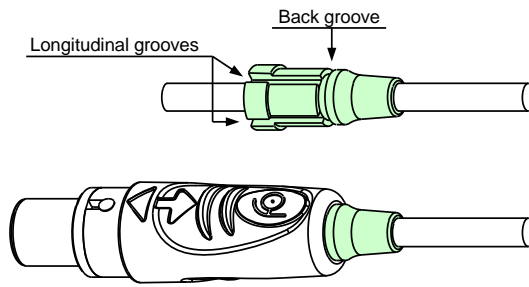
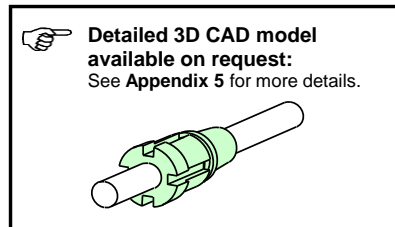
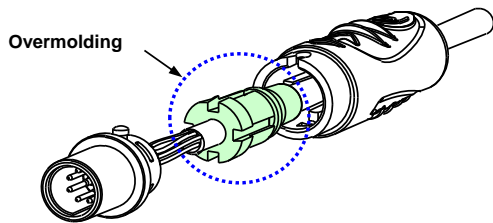

B) Two-Piece Shell

- ☞ The back side of the Overmolding must be positioned at distance **L5** from the back side of the Insulator. Other considerations like the cable size and the esthetical aspect will guide the definition of the outer geometry.

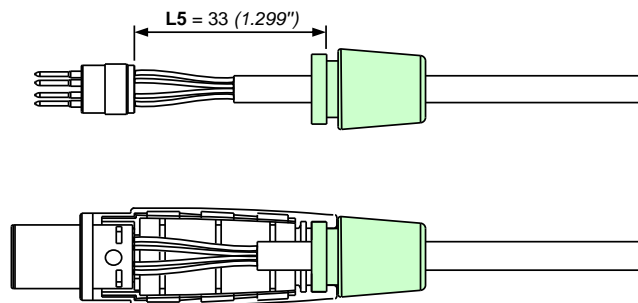
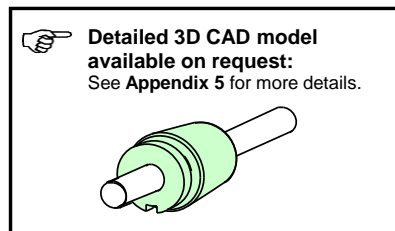
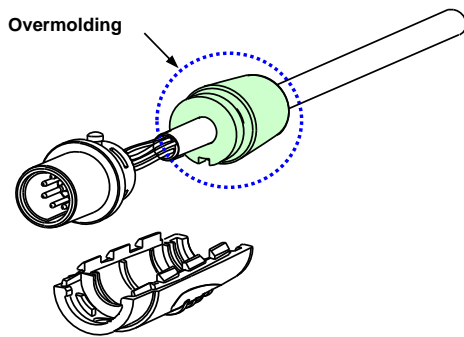

All dimensions shown are in millimeters (*inches*) and are for reference only.



APPENDIX 4 - Suggestions for Inner Customization

The inner geometry of the Bottom Shell can be customized to allow implementation of special features. Cable retention, fixation of electronic components (as pictured below) are some examples of the wide array of possibilities that can be achieved.

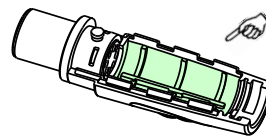

Customizable inner area of Bottom Shell

A) Simple cable retention

☛ **2 pins** can provide a simple cable retention for small diameter cables

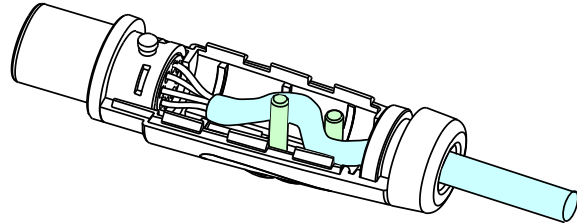
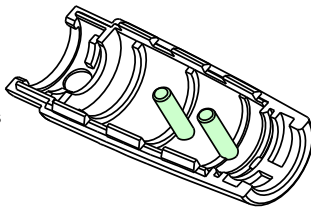

B) Fixations for printed circuit board

☛ **2 pins**

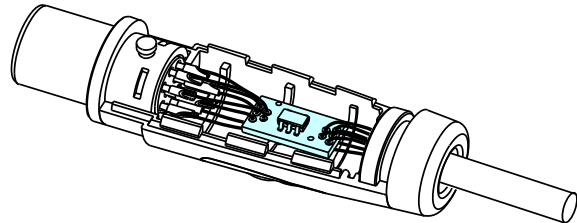
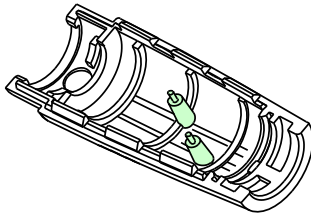

☛ **Frame**

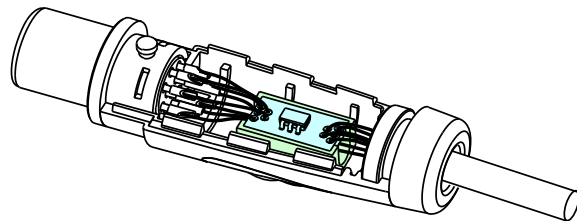
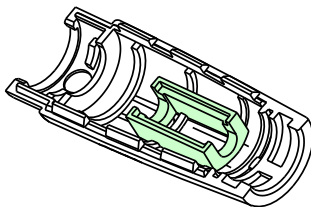

APPENDIX 5 - Documents and 3D CAD Model Files

- **Summary of Qualification Test Reports** P2320_Test_Summary
- **FMEA Design** (Failure Mode and Effects Analysis) P2320_FMEA-Design (*)
- **3D CAD Model Files** (STEP and IGES formats available)
 - **For Two-Piece Shell**
 - Available Inner Volume
 - Overmolding of Cable Retention 2320_234 (*)
 - 2320_242 (*)
 - **For One-Piece Shell**
 - Overmolding of Cable Retention
 - **For Snap-in Plug** 2320_237 (*)
 - Top Fixation
 - Bottom Fixation
 - 2320_235 (*)
- * *Non-Disclosure Agreement (NDA) required* 2320_236 (*)

If you would like a document listed above, please contact your local Fischer office. www.fischerconnectors.com